

1	.06.286.00.10.00		2080 x 518	1	16,0	1/7
2	.06.286.00.11.00		2080 x 518	1	16,0	1/7
3	.06.286.00.03.00		702 x 540	2	16,0	2/7
4	.06.286.00.04.00		668 x 518	4	16,0	2/7
5	.06.286.00.14.00		668 x 80	2	16,0	4/7
6	.06.286.00.06.00		668 x 128	1	16,0	4/7
7	.06.286.00.12.00		1996 x 396	2	/	3/7
7.1	.06.286.00.12.01		1996 396	2	16,0	3/7
7.2	.06.286.00.07.02		474 96	8		3/7
8	.06.286.00.13.00		1996 x 296	2	16,0	3/7
9	.06.277.00.06.00		666 x 516	3	16,0	2/7
10	.06.277.00.04.00		2080 x 518	1	16,0	1/7
11	.06.277.00.05.00		2080 x 518	1	16,0	1/7
12	.06.286.00.09.00		2012 x 347	4	4,0	1/7
13	.06.278.00.31.00		2000 x 540	1	16,0	4/7
14	.06.278.00.32.00		1966 x 518	1	16,0	4/7
15	.06.278.00.33.00		1966 x 80	2	16,0	4/7
16	.06.278.00.34.00		480 x 518	1	16,0	4/7
17	.06.278.00.35.00		480 x 518	1	16,0	4/7
18	.06.278.00.06.00		1296 x 518	1	16,0	4/7
19	.06.278.00.36.00		384 x 518	1	16,0	4/7
20	.06.278.00.37.00		384 x 518	1	16,0	4/7
21	.06.278.00.09.00		198 x 518	1	16,0	4/7
22	.06.278.00.45.00		170 x 518	1	16,0	5/7
23	.06.278.00.38.00		396 x 346	2	16,0	4/7
24	.06.278.00.39.00		644 x 200	1	16,0	4/7
25	.06.278.00.40.00		644 x 200	1	16,0	4/7
26	.06.278.00.46.00		350 x 100	2	16,0	5/7
27	.06.278.00.47.00		350 x 100	2	16,0	5/7
28	.06.278.00.16.00		584 x 100	2	16,0	5/7
29	.06.278.00.17.00		615 x 358	2	4,0	4/7
30	.06.278.00.18.00		405 x 348	2	4,0	4/7
31	.06.278.00.48.00		1272 x 298	2	16,0	5/7
32	.06.278.00.49.00		1272 x 298	1	16,0	5/7
33	.06.278.00.50.00		1272 x 298	1	16,0	5/7
34	.06.278.00.22.00		315 x 270	6	4,0	5/7
35	.06.278.00.23.00		2000 x 340	1	16,0	4/7
36	.06.278.00.24.00		1296 x 250	1	16,0	5/7
37	.06.278.00.51.00		950 x 220	2	16,0	5/7
38	.06.278.00.52.00		165 x 165	4	16,0	5/7
39	.06.278.00.27.00		295 x 490	2	16,0	4/7
40	.06.278.00.28.00		306 x 1296	1	16,0	4/7
41	.06.278.00.29.00		1262 315	2	4,0	6/7
42	.06.278.00.30.00		1295 348	2	4,0	4/7

06.286.

.56 .1, 2 .60 3 16 .65
 4 16 .67. .1, 2 .54
 .4, .5 .3. .1, 2
 .71 3,5 16 .66. 3 16 (.65)
 .12, .73. 7.2
 .77 7.1 ,









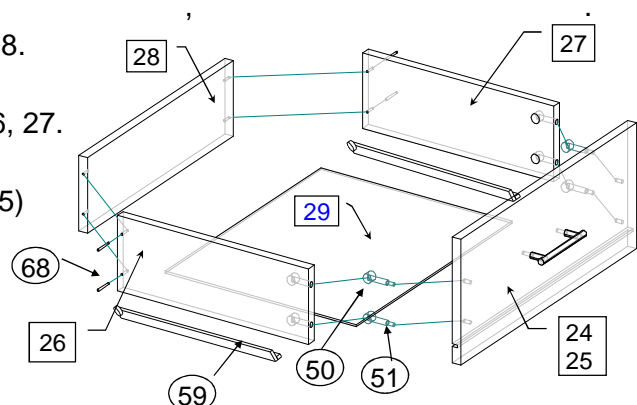











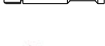

06.277.

.56 .10, 11 .60 3 16 .65
 4 16 .67. .10,11 .54
 .4, .5 .3. .9
 .62. 3 16 (.65)
 .73. .12,

06.278.

.16, 17 .15 3 16 (.65) .60
 4 16 (.67) .56. .19, 20, 22
 3,5 16 (.66) .59
 (.50, 64) .21, 22
 .18. .54 .18
 .19, 20. .19, 20, 22
 .14. .54 .16, 17
 .14 .15. .54 .39, 40
 .35, .36 .32, 33,
 37, 40, .31, 32, 33 .35 .31,
 32, 33, 37 .32, 37 33, 37.
 .13 .50, 51
 .16, 17, 19, 20, 21 .13. 3 16
 .30 42, .58. .34
 .63. .60 .41, (.1).
 !
 1. 4 30 (.68) .26, 27, 28.
 2. (.50, 51)
 3. .24 (25)
 .57
 4. .26, 27, 28.
 .26, 27
 3,5 * 16 (.66)
 (.59) .
 .61. .7, 8, 23.
 .70. .52, 53 .72.
 .76 (



	50	22
	51	DU 232 . Ø 5 . 18
	52	22
	53	96
	54	7 50 96
	55	2
	56	0 20
	57	6
	58	() 6
	59	L=350 . 2
	60	16
	61	16
	62	12
	63	24
	64	2
	65	3 * 16 180
	66	3,5 * 16 22
	67	4 * 16 80
	68	4 * 30 8
	69	2
	70	8
	71	2
	72	L=662 . 1
	73	L=1980 . 2
	74	4
	75	8 30 2
	76	Ø5 (L=27 .) 4
	77	48

- 1.
- 1.1
- 2.
- 2.1
- 2.2
- 2.3
- 2.4

+5 40 .

+40 .

025/2012 " " 16371-2014 « .»

24

() .

025/2012, 16371-2014

()

10 .

606 400 , 27.

WEB- : www.olmeko.ru / 8(83144) 66-777

